



THE MOBILE & FLEXIBLY USABLE AIRCLEANER

FOR KITCHEN & LIVING AREA,
MEDICINE, HOTEL & GASTRONOMY

OZONOS®

TABLE OF CONTENTS

FINALLY FRESH AIR	03
THE OZONOS PRODUCT WORLD	04
COOKING AND LIVING? ONLY WITH OZONOS	06
WHY OZONOS AND HOW DOES IT WORK?	07
OZONE ONLY DOES ITS JOB AND DISAPPEARS.	08
WHERE CAN OZONE BE FOUND?	09
THE CEILING LAMP „STELLA“	10
THE FLOOR LAMP „HAILEY“	12
THE OZONOS TRIPOD	16
THE OZONOS KITCHEN MODULE	18
OZONOS IN BUSINESSES	19
FIELDS OF APPLICATION	20
WHICH OZONOS SUITS US?	28
DISINFECTION THROUGH CONTROLLED OZONE OUTPUT	30
TÜV CERTIFICATE	31
OZONOS TECHNICAL DATA SPECIFICATIONS & FEATURES	33
OZONOS USER EXPERIENCES	34



FINALLY FRESH AIR!

HIGH QUALITY OF LIFE AND HEALTHY LIVING!

Fresh air is essential for our well-being –there’s no doubt about that. Whether it is in the private kitchen, where the fish in the pan has just gone crazy, in the pollen contaminated bedroom, in the stuffy locker room at the gym or even in a doctor’s waiting room, that is contaminated with viruses. All of us are constantly longing for fresh, clean air.

The mobile Aircleaner eliminates aerosolfats, bacteria, viruses, germs, mold spores, pet and mite allergens, pollen, odors, pet and colour odours at home or at work – with an innovative patent that utilizes the natural benefits of ozone.

THE OZONOS PRODUCT WORLD

MANY WAYS LEAD... to fresh and clean air!
OZONOS offers a broad range of products, so that
everyone can find one that meets their individual needs!

Be curious, because we constantly extend our assortment!



OZONOS AC-I LINE



FLOOR LAMP „HAILEY“



CEILING LAMP „STELLA“



OZONOS KITCHEN MODULE

OZONOS TRIPOD



COOKING AND LIVING? ONLY WITH OZONOS!

STAR CHEF MIKE SÜSSLER IS MORE THAN CONVINCED BY THE OZONOS® AIRCLEANER. COOKING AND LIVING WITHOUT OZONOS® IS OUT OF THE QUESTION FOR HIM!

»I never thought that this handy device has such an enormous power. The stylish Aircleaner OZONOS is not only the most awesome mobile extractor hood that I have ever seen, but also an absolutely convincing fresh air miracle that should not be missing in any kitchen and especially in any living area.«

MIKE SÜSSLER | TV CHEF

Known from »Mein Lokal dein Lokal –der Profikommt« (Kabel1), »Promis am Herd« (RTL II), »Die Kochprofis–Einsatz am Herd« (RTL II), »SüSSLER am morgen« (ServusTV) and many more.



WHY OZONE & HOW DOES IT WORK?

Ozone, also known as active oxygen, is a naturally occurring substance and consists of three oxygen atoms (O₃). It therefore has one oxygen atom more than the vital oxygen in our breathing air (O₂). This third oxygen atom makes ozone a highly reactive substance. It tries to form a bond with other substances or disintegrates into O₂ again. We make use of this attribute to neutralize smells, bacteria, viruses, germs, pollen, etc. Especially proteins and fats are those substances which react quickly with ozone and decompose. If ozone does not find a substance with which it can react, it decomposes into O₂ (oxygen) automatically after a short time. These are exactly the properties we need.

In everyday life we know ozone mainly from the ozone layer which protects us and as an air pollutant close to the ground. As a pollutant, ozone is mainly formed from emissions and solar radiation (summer smog). Ozone is therefore only ONE component of a pollutant cocktail. Its harmfulness lies particularly in the excessively high concentrations and other harmful additives. A clear distinction must be made from summer smog: First, for its function the OZONOS Aircleaner only produces ozone in low concentrations and no harmful pollutants. Secondly, even under unfavourable conditions, the ozone concentrations remain in continuous operation in a safe range of less than 0.05 ppm, e.g. with the OZONOS AC-1 version (TÜV certification, testing of each individual UV-C lamp).

EU Directive 92/72/EEC (thresholds)

According to the EU directive, ozone does not pose a health risk at a concentration of 0.06 ppm. Information threshold / alarm threshold at 0.12 ppm. More information at EU Directives www.eur-lex.europa.eu or Bavarian State Office for the Environment www.lfu.bayern.de



OZONE ONLY DOES ITS JOB AND **DISAPPEARS.**

OZONOS TECHNIQUE

INSPIRED BY NATURE

For the production of ozone we copy the natural formation of it in the ozone layer.

In combination with oxygen (O₂), the UV-C light of the sun produces ozone (O₃).

The OZONOS Aircleaner uses exactly this principle: The UV-C bulb in the OZONOS Aircleaner takes on the role of the sun.

Contrary to the usual methods and environmental processes, no harmful nitrogen oxides are produced.



- No odour
- No bacteria
- No viruses
- No germs
- Only pure oxygen

OZONE GENERATORS

SO FAR: TOO MUCH OZONE, TOO LOUD AND TOXIC NITROGEN OXIDES



Not appropriate for use in occupied rooms.

Until now, ozone for domestic use has been generated by so-called ozone generators. These devices use very high voltages to generate ozone and/or ionized air by means of electrical discharges (corona discharges). On the market they are also called ionizers. The disadvantage: corona discharges produce toxic nitrogen oxides (NOX) in the air - the main pollutant of summer smog and absolutely undesirable in room air.

In addition, the amount of ozone produced, usually more than 1,000 mg/h, is much higher than, for example, 2.5 mg/h for OZONOS (model OZONOS AC-1).

The use of conventional ozone generators for odour neutralisation and disinfection of rooms is only possible in a very controlled way, for example if the room is not entered for several days, as in the case of a crime scene cleaning. In addition, the noise level is often indicated with more than 45 db (audibly loud, concentration disturbance).



WHERE CAN OZONE BE FOUND?

IN THE LAST FEW YEARS THERE HAS BEEN AN ENOURMOUS CHANGE IN THE SUBJECT OF OZONE.

In medicine, the use of ozone has been common for some time, for example in dentistry or for blood treatments.

The table below shows where ozone can be found in our daily lives and how it can be used. It can be clearly seen that our OZONOS AC-I is very far below the threshold values and specifications of the EU and the legislator.

Ozone is the most important gas in our environment and keeps nature in balance. We make use of this principle in our OZONOS products.

TYPICAL OZONE-CONCENTRATION IN PPM (PARTS PER MILLION)

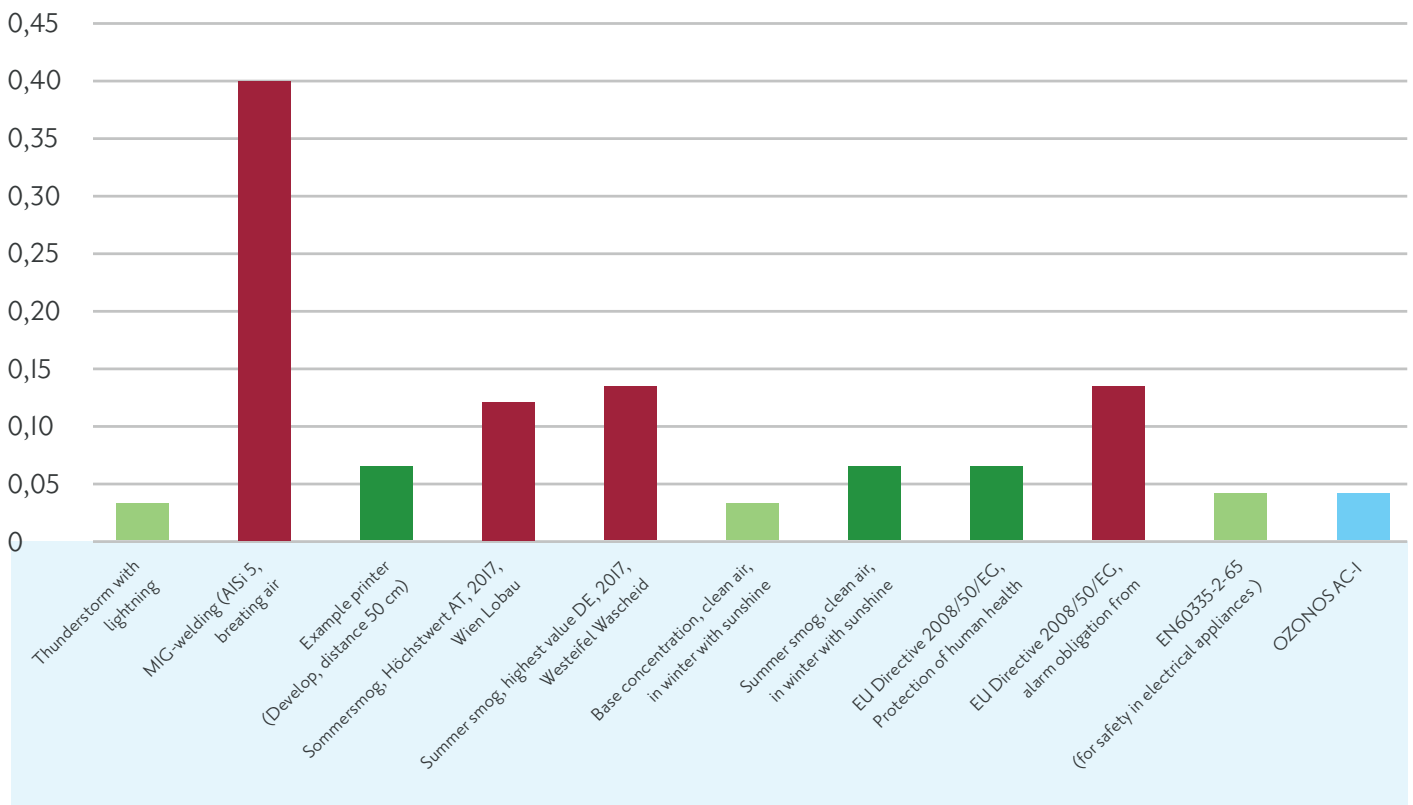



NEW

THE OZONOS CEILING LAMP „STELLA“

Everyone knows the annoying odours and aerosol fats in their kitchen, but nobody likes to place unsightly extractor hoods into their carefully planned kitchen.

OZONOS has the ideal solution!

Our new ceiling light "Stella" convinces not only with stylish design, but also with inner qualities: an integrated OZONOS AC-I PLUS! It brings light into the kitchen and at the same time eliminates unwanted odours and aerosol fats. Of course, the Aircleaner and the lamp can also be controlled separately.



Anthracite RAL7016



White RAL9016

DESCRIPTION CEILING LAMP „STELLA“:

LENGTH:	1060 mm
WIDTH:	550 mm
HEIGHT:	220 mm
WEIGHT:	16,5 kg
LED-Strip 80W 24V 5700lm 2700K CRI>=90	
Driver & OZONOS AC-I PLUS integrated incl. remote control, surface metal case in white (RAL9016) or anthracite (RAL7016), surface glass A-WS acrylic white satined	



Jeans Grey

NEW LIFE QUALITY WITH „HAILEY“ – THE FLOOR LAMP

Hailey, the first fresh air floor lamp has everything you need to eliminate odours, germs, viruses and bacteria: an OZONOS Aircleaner inside the lampshade, a simple function and an innovative, modern design.

Experience fresh air in a different way.



FUNCTION MEETS
MODERN DESIGN



Linen Nature



Athene Creme

DESCRIPTION FLOOR LAMP "HAILEY":

DIAMETER:	Ø600 mm
HEIGHT:	1740 mm
WEIGHT	19 kg
LED:	24V/230V
54W, 4950lm, 2700K, CRI 90	

Jeans Grey



Linen Nature



Athene Creme



„HAILEY“ – THE FLOOR LAMP

DESIGN MEETS FUNCTION

The floor lamp "Hailey" combines the best of design and hygiene, since our OZONOS AC-I is hidden inside the modern and stylish lampshade.

INNOVATIVE AND STYLISH

The light and the OZONOS AC-I can be controlled separately, as well as simultaneously. The OZONOS AC-I silently and secretly purifies the air and sustainably improves your quality of life.







NEARLY UNLIMITED APPLICATION
WITH THE **OZONOS TRIPOD**



OZONOS STATIV

(COMPATIBLE WITH THE OZONOS AC-I LINE)

- Easy adjustment and transport
- Ideal air circulation due to higher placement of the device
- Individual and easy height adjustment due to leg clamps and 3 air-damped extracts
- Including wheels. E.g. for use in hotel rooms.

DESCRIPTION OZONOS TRIPOD:

DIAMETER:	33-29-25 mm
HEIGHT:	maximum 300 cm
NET-WEIGHT:	1,6 kg
LOAD:	9 kg



THE OZONOS KITCHEN MODULE

For all those who don't want to be without their OZONOS Aircleaner anymore - we have good news!

The AC-I line can now be integrated into every planned and already existing kitchen due to our new individually adaptable kitchen module!

The new kitchen module is available exclusively at our kitchen partners, such as HAKA Küche or Sachsenküchen. For detailed information, please contact your favourite kitchen manufacturer!



EXAMPLE CABINET INCL. KITCHEN MODULE

DOCTORS PRACTICES: WAITING ROOMS NO LONGER HAVE TO BE GERM-MAGNETS

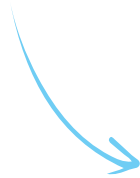

OZONOS IN **BUSINESSES**

HOTEL ROOMS

Fewer pathogens even at high room occupancy

FITNESSCENTERS

Locker rooms and solariums free from odors and germs

KINDERGARDENS

Locker and bath rooms without odors and germs

DOCTORS PRACTICES

Reduction of bacteria, viruses and germs in waiting rooms





APPLICATION IN KINDERGARDENS & SCHOOLS

OZONOS APPLICATION:

- Reduction of germs and odours in toilets
- Odourless locker rooms
- Reduction of bacteria in class rooms
- Hygenic Gyms and Common rooms

Also eliminates odours in clothing. Designed to be used in wardrobes and small rooms too



NEARLY UNLIMITED APPLICATION IN LIVING AREAS, KITCHENS AND BATH ROOMS

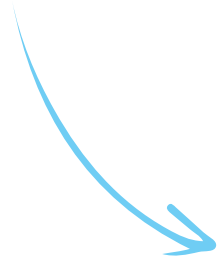

There are more bacteria and germs in our homes than you might imagine. With our mobile Aircleaner OZONOS you can eliminate them completely.

The special characteristic of our AC-I: You do not have to leave the room during operation and it is designed for 24/7 use.

OZONOS APPLICATION EXAMPLES:

- Allergy-friendly rooms
- Storage rooms
- Improvement of the shelf life of foods
- Removal of germs, bacteria as well as odours in the kitchen

and many more ...

PLACEMENT

The best results are achieved when the device is placed at the height of 2m or more.

NEARLY UNLIMITED APPLICATION IN HOTELS & GASTRONOMY

OZONOS APPLICATION EXAMPLES:

- Guest, common and meeting rooms
- Skiboot and drying rooms
- Kitchen area
- Fitness area
- Spa-Area, Changing rooms & Solariums
- Smoking areas
- Hotel rooms

AND MANY MORE ...



ALSO DESIGNED
FOR THE
USE INSIDE
WARDROBES

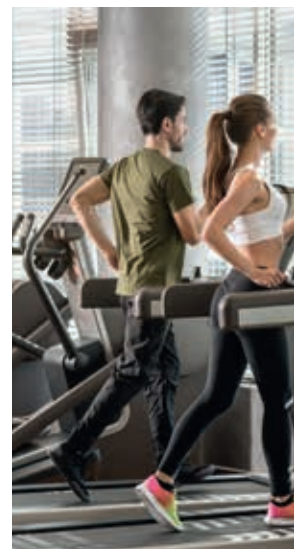
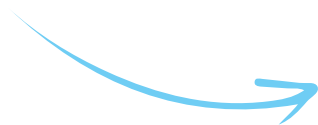



MIKE SÜSSER
RECOMMEN-
DATION

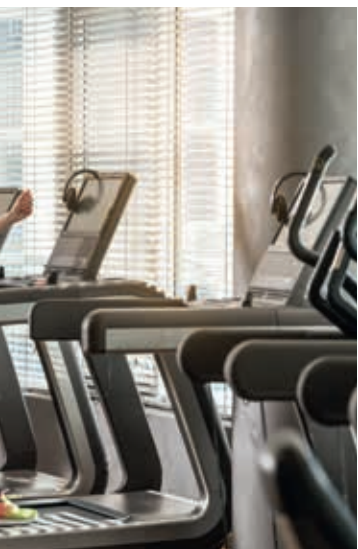





NEARLY UNLIMITED APPLICATION IN THE MEDICAL SECTOR

OZONOS APPLICATION EXAMPLES:

- Pharmacies
- Hospital rooms
- Doctors practices
- Waiting rooms / receptions
- Hospital Laundry Rooms
- Vet Practices
- Physiotherapy Rooms

AND MANY MORE ...



DOCTORS
PRACTICES &
WAITING ROOMS
NO LONGER HAVE
TO BE GERM-
MAGNETS



OZONOS FOR ALLERGY SUFFERERS



MORE HYGIENE
IN GERM
BURDENED
ROOMS

The mobile Aircleaner OZONOS is especially suitable for allergy sufferers. No matter if pollen allergens, animal hair or house dust - if the air is polluted by allergy-causing components, this is a horror for allergy sufferers during the day and at night. OZONOS cleans the air and additionally ensures hygiene in germ-contaminated living rooms and bedrooms.

OZONOS requires neither chemicals nor filters and, thanks to its extremely low energy consumption, can be used around the clock.

ENVIRONMENTALLY FRIENDLY, SUSTAINABLE AND ABOVE ALL HARMLESS TO HEALTH

Disinfection with ozone is considered one of the most environmentally friendly methods of achieving sustainable elimination of unpleasant odours and harmful microorganisms. No filters or chemicals are required.

MORE EXAMPLES: Shoe rooms, wardrobes, caravans and yachts in winter storage.

IMPROVED CLIMATE TO LIVE AND WORK

Numerous tests and studies prove that the use of the OZONOS Aircleaner is harmless for you and your four-legged friends: When used correctly, the limit values are adhered to and there is no UV-C exposure outside the device.

The ozone is generated by the device and, due to its responsiveness, immediately reacts with germs, spores, odours, etc.

If nothing is left, the ozone quickly decomposes to normal oxygen due to its short half-life.,

In the sleeping area, the proteins of the skin cells or pollen are removed. As a result, mites lose their food and die, leading to a significant improvement in air quality for allergy sufferers.



ABSOLUTELY
HARMLESS FOR
HUMANS AND
ANIMALS

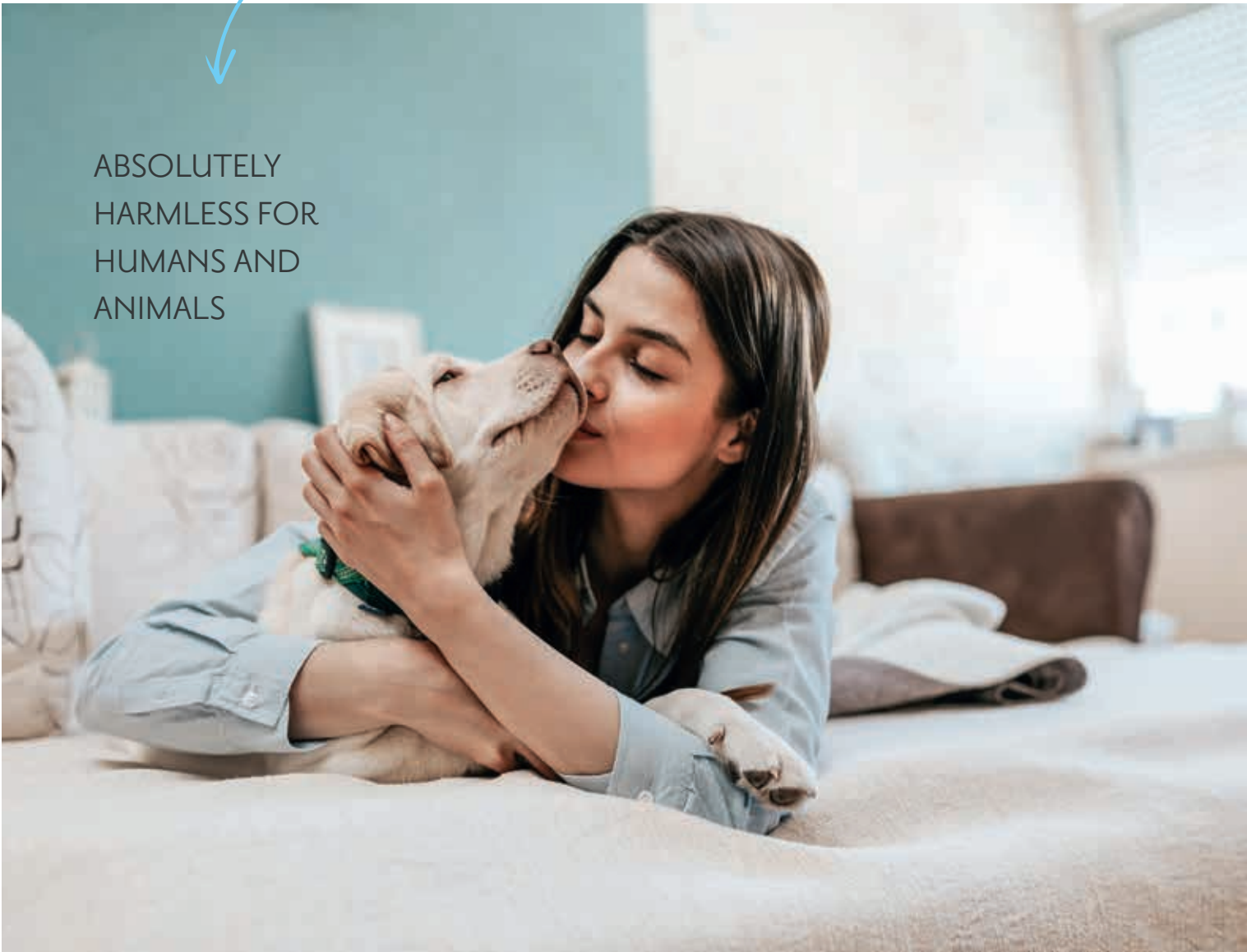

WITHOUT OZONOS

Harmful emissions



Bacteria & Mould spores



Fumes & Odours



Viruses & Allergens



Skin cells



WHICH OZONOS SUITS US?

All three versions are available in all three colours



OZONOS AC-I



OZONOS AC-I PLUS*



OZONOS AC-I PRO*

**WE CREATE A BETTER CLIMATE
TO LIVE AND WORK**

WITH OZONOS



The OZONOS AC-I

is designed for permanent use and therefore allows you to be in the same room 24/7. Particularly suitable for smaller rooms such as cold storage rooms or hotel rooms.

Elimination of normal odour disturbance or low levels of bacteria, viruses or germs. Perfect for creating allergy-friendly rooms.

The OZONOS AC-I PLUS*

is designed for quick and intensive cleaning. It is particularly suitable for heavy and strong odours or a high bacterial, viral or germ load.

Used e.g. in ski shoe rooms, larger rooms, kitchens or cooling rooms, etc.

The OZONOS AC-I PRO*

aims very strongly at the professional user or also for the private area. In areas where it is important to achieve a convincing result within the shortest time.

Areas of application: Garbage rooms, ski shoe rooms, heavily odour-contaminated and germinated areas.

*The OZONOS AC-I PLUS and AC-I PRO are not designed for 24/7 use where people stay in the same room permanently. We recommend not to stay in the room for longer than 8 hours when operating the device. OZONOS AC-I PLUS and AC-I PRO are particularly suitable for professional use and for quicker and more intensive cleaning.

DISINFECTION THROUGH CONTROLLED OZONE OUTPUT

OZONOS in detail: The integrated fan draws polluted air into the interior of the OZONOS. The specially developed UV-C bulb generates ozone from the oxygen in the air. The highly reactive ozone immediately reacts with odour molecules, proteins and fats. Odours, spores, germs etc. are thereby eliminated. The cleaned air is then returned to the room.

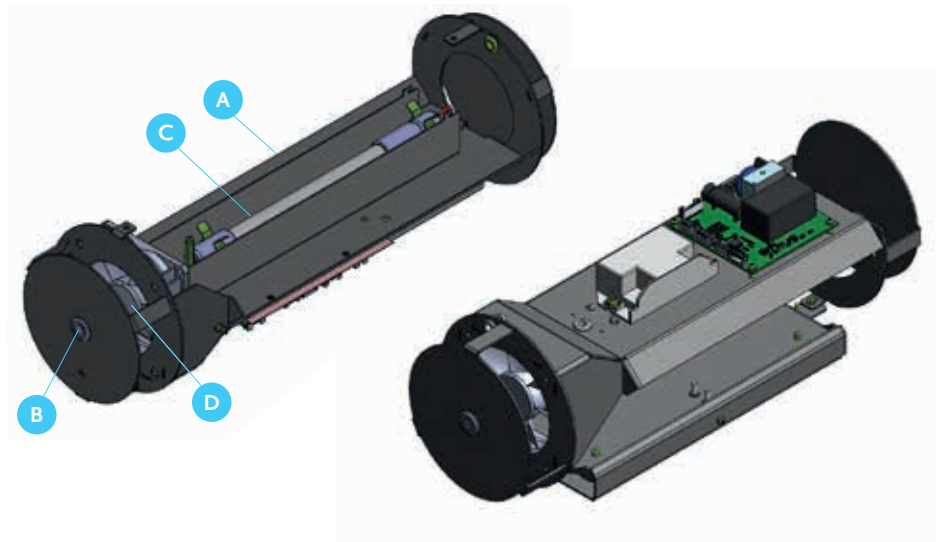
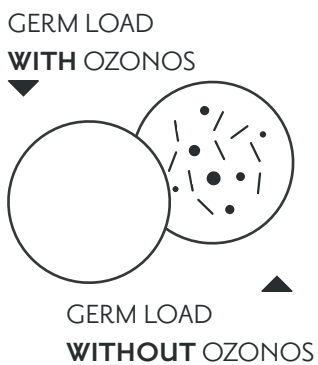

A Case · B On/Off button with blue control light · C UV-C special bulb · D Fan

EVERYTHING FOR YOUR SAFETY

TÜV CERTIFIED AND CONVINCING IN NUMEROUS TESTS

The device produced according to ISO 9001:2015 was successfully tested in the laboratory by TÜV SÜD Product Service for compliance with legal standards (EN60335-2-65, maximum 0.05 ppm ozone concentration) and certified by Quality Austria Trainings, Zertifizierungs und Begutachtungs GmbH. In addition, long-term and stress tests as well as the CE Declaration of Conformity prove the safety, electromagnetic compatibility and interference immunity.

The OZONOS AC-I is therefore not only effective in practice, but also tested by independent tests and therefore harmless to health.



Produced according to DIN 9001:2015



MADE IN AUSTRIA

TÜV CERTIFICATE

TEST REPORT OF
MARCH 20, 2017
No. 24493-01305-01
(Edition I)

TEST BASIS
EN 61000-6-3:2007 + A1:2011
+ AC:2012
EN 61000-6-2:2014
EN 61000-6-3:2013
EN 61000-6-6:2007

TEST RESULTS

FULFILLED

The tests were successfully passed.

TEST FOR INTERFERENCE IMMUNITY

- ✓ radiated disturbances
- ✓ harmonics
- ✓ voltage fluctuations
- ✓ interference voltage
- ✓ electromagnetic HF fields
- ✓ static electricity discharge
- ✓ asymmetric high frequencies
- ✓ fast transients
- ✓ surge voltages
- ✓ voltage dips and interruptions

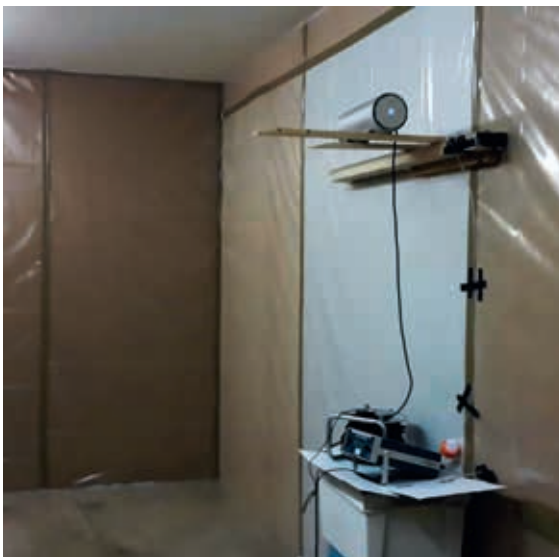

MEASURING
In the testing room



MEASURING
voltage fluctuations



MEASURING
Electromagnetic HF fields

QUALITY MADE IN AUSTRIA

TEST REPORT OF 22 JUNE 2016

Registration No.: 01511/0

TEST BASIS

Quality Management System

Standard: ISO 9001:2015

CERTIFICATION ISSUE

Quality Austria -Trainings, Zertifizierungs und Begutachtungs GmbH issues a **qualityaustria** certificate to our manufacturers:



Digital Elektronik Ges.m.b.H
A-5083 St. Leonhard bei Salzburg,
Berchtesgadner Straße 10

A-5580 Tamsweg
Johann-Kopfmüllerstraße 6



Digital Elektronik d.o.o.
Ul. Kninska bb
BH-74400 Derventa

TEST RESULTS

FULFILLED

Confirmation of the application and further development of an effective quality management system.

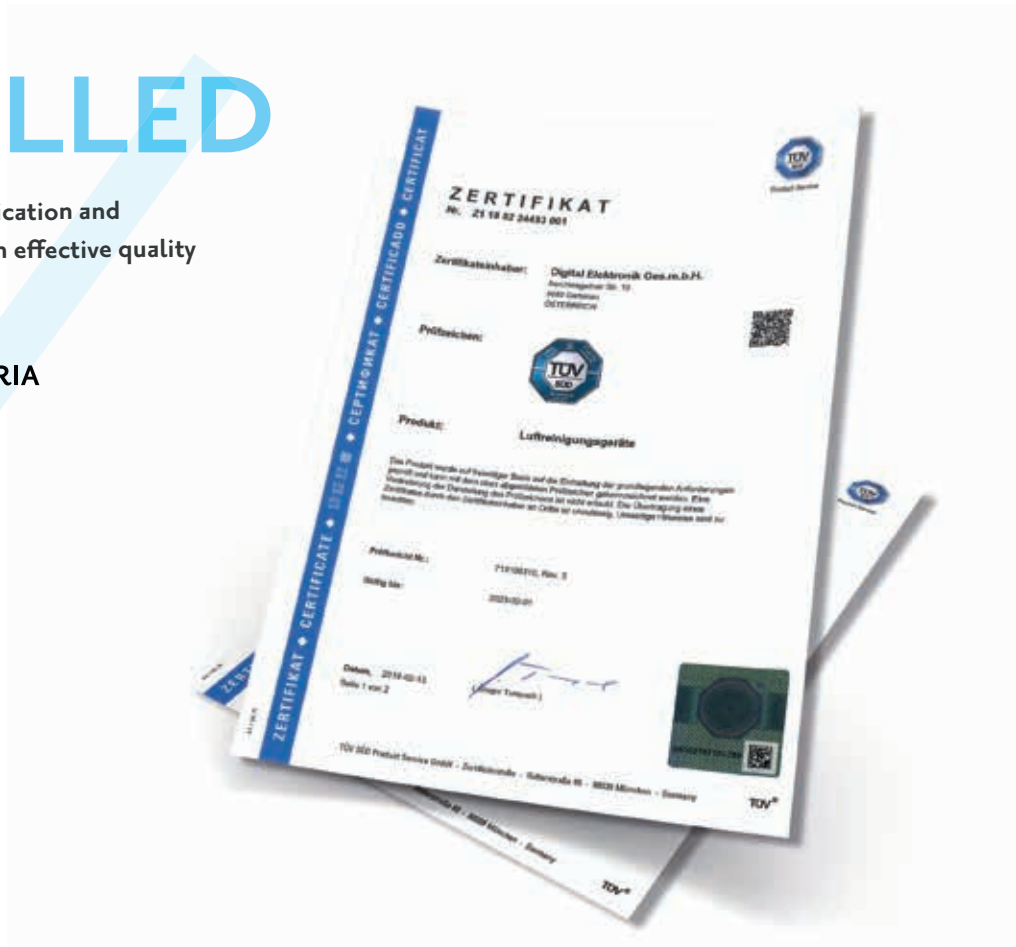

OZONOS TECHNICAL DATA

SPECIFICATIONS & FEATURES



	10%	25%	50%
OZONE CONCENTRATION		0,048 ppm	0,115 ppm
UV-C COATING	10%	25%	50%
	OZONOS AC-I	OZONOS AC-I PLUS*	OZONOS AC-I PRO*
MEASUREMENTS	L 400 mm · Diameter 130 mm · Weight 2,7 kg		
UV-C BULB	1 x 8 watt	1 x 8 watt	1 x 8 watt
INPUT POWER	14 watt	14 watt	14 watt
UV-C BULB	Durability of the UV-C bulb: 8.000 operating hours		
AIR FLOW RATE p.h.	ca. 55 m ³ ca. 25 m ²	ca. 55 m ³ ca. 25 m ²	ca. 55 m ³ ca. 25 m ²
VOLUME	37 db	37 db	37 db
REMOTE CONTROL	yes	yes	yes
COLOURS	Every version is available in all colours! black – powder-coated silver – powder-coated white – powder-coated		

*The OZONOS AC-I PLUS and AC-I PRO are not designed for 24/7 use where people stay in the same room permanently. We recommend not to stay in the room for longer than 8 hours when operating the device. OZONOS AC-I PLUS and AC-I PRO are particularly suitable for professional use and for quicker and more intensive cleaning.

THIS IS WHAT OZONOS-USERS SAY

Let yourself be inspired by some of the first-hand experiences of our customers.



»The OZONOS devices are used in several versions in various rooms and areas of the restaurant "Meyers Keller". We are very satisfied with the performance of the devices. With their modern design and easy handling, they are perfect for our needs. We will buy even more OZONOS Aircleaners!«



Jockl Kaiser
Star Chef & Manager of Restaurant
Meyers Keller
www.jockl-kaiser.de



Tim Raue
Star Chef & Manager of Restaurant Tim Raue
www.tim-raue.at

»In the Smile Clinic Salzburg we use the OZONOS® system for disinfection of the bacterial or viral contaminated aerosol cloud, which develops during the dental treatment. In this way we actively protect our employees from illnesses.«



Dr. med. univ. et med. dent
Sehdi Sarmini
Economic Clinic Management
www.smile.at

»In our restaurants and kitchens we use the OZONOS. The OZONOS keeps our kitchens free of germs and bacteria and minimises the development of odours in the dining room. We are very pleased with the functionality and can warmly recommend OZONOS.«



Didi Maier
Star Chef & Gastronomer
www.didimaier.com

»With our two children and one cat, it's hard to create a 100% germ-free home at all times and everywhere. As a family, we also enjoy cooking. The OZONOS provides us with fresh and healthy air - and our health thanks it.«



Dana Laudenschach
Housewife & Mother

»For our Alm Resort we bought the OZONOS Aircleaner. Germ and bacteria free rooms are the absolute added value for us. We will buy more OZONOS AC-I to be able to offer our guests rooms for allergy sufferers in the future.«



Mario Eichelhardt
Alm Resort Nassfeld
www.almresort-nassfeld.com

»Thanks to the OZONOS Aircleaner, we are in a very uncomplicated and elegant position to reduce the odours of our kitchens and lounges. We also use this great device to make the rooms of our romantic hotel even more pleasant for our guests.«



Family Gmachl
Romantik Hotel Gmachl
www.gmachl.com

»We use the OZONOS® Aircleaner in our treatment and waiting rooms to protect our patients from germs and bacteria even better. In addition to this increased protection, it is also a great side effect that odours are eliminated across all areas.«



Dr. med.
Katharina Reschen
Practice Management
www.ord-reschen.com

»We became aware of the OZONOS products at the GAST fair. After a short test in our house we were completely convinced of the quality and since then we use an OZONOS AC-I PLUS for odour removal and disinfection of hotel rooms. As one of the top hotels, it is important to us to always be able to offer our guests the best quality.«



Stefanie Poschinger
Housekeeping at Hotel Sacher
www.sacher.com

»We use 2 OZONOS devices in our pharmacy to eliminate unpleasant odours and protect our employees in the public area from infection by germs, viruses and bacteria which are inevitably brought into the pharmacy by our customers / patients.«



Mag.
Michael Baumgartner
Die Apotheke Eugendorf

»We have recently started using the OZONOS Aircleaner in the Krabbelstube Kuschelkiste. The air quality (unpleasant odours) has noticeably improved, especially in the movement room and the sleeping room.«



Karin Schosser
Team Management Krabbelstube Kuschelkiste
www.kuschelkiste.at

»The air quality in my practice has improved considerably through the use of OZONOS. This is especially noticeable in the waiting room. Even with a high number of patients the room climate does not suffer and the reduced germ load is an additional benefit for staff and patients.«



Dr.
Susanne Obermann
Salzburg

»I always had lots of problems with my allergy. After a long search I finally found something that really helps and that I can rely on: the OZONOS Aircleaner! Since I have it at my side, my allergy cannot harm me any more. I feel much more stable and healthy!«



European rowing champion
Magdalena Lobnig
2x bronze at world championships
www.madalenalobnig.at

»In our two hotels Neutor and Neutor Express in Salzburg we have recently started using an OZONOS AC-I PRO device to eliminate unpleasant odours primarily in our rooms and to offer our guests a hygienic atmosphere in their rooms. We are already considering equipping other areas with OZONOS devices.«



Axel Teckentrup-Kurz
Director of Hotel Neutor Betriebs GmbH
www.neutor.com



MIKE SÜSSER
RECOMMEN-
DATION

THE FIRST OZONE DEVICE WITH
TÜV CERTIFICATION
& CE-APPROVAL



HAKAKÜCHE

HOLTER



LOHBERGER

**SACHSENS
KÜCHENS**

WINTERSTEIGER

elastica
SCHLAFSTÜTZE

METRO

HÄFELE

FUST

MZE
NETZWERK WOHNKULTUR

EK/servicegroup

Europa Möbel
Einkauf & Marketingcenter

SECOMP

YOUR CONTACT:

OZONOS GMBH

Friedensstraße 2-6 · A-5020 Salzburg
M frischluft@ozonos.at · W www.ozonos.at

OZONOS SCHWEIZ GMBH

Kirchstrasse 5 · CH-8104 Weiningen
M frischluft@ozonos.ch · W www.ozonos.ch

OZONOS ASIA

Peter Murhammer
83/11 Moo 4, Koh Kaew Sub District, Muang-
Phuket District · Phuket Province 8300
M asia@ozonos.at · W www.ozonos.at